

# Enthalpy Plate Heat Exchanger VAPOBLOC

## Energy recovery for a healthy indoor climate







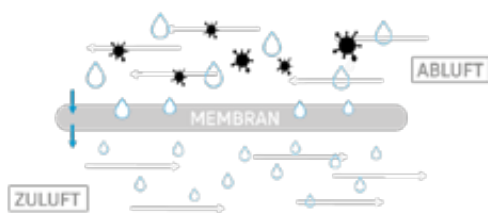

### Transfers heat and humidity - tight against germs and smells

During the winter months we spend about 90% of our time inside buildings. Dry throats, stinging eyes and dry skin are often the uncomfortable results of arid, heated winter air.

These symptoms can be eliminated by using the Vapobloc from POLYBLOC as cross- and counter-flow pleat heat exchanger. This specially designed energy exchanger transfers the heat and humidity from the return air to the supply air but leaves out smells, spores and bacteria. Vapobloc is ideal for sensitive areas such as hospitals, schools, residential homes and apartment houses.



-  Humidity transfer. With the special Polymer-Membrane both humidity and heat are transferred from return air to supply air. Indoor air quality is therefore greatly increased.
-  High heat transfer.  
Different sizes allow for optimal sizing to comply with the requirements.
-  This vapor permeable membrane allows the transfer of water vapor molecules. Other components such as air, smells, spores and bacteria are prevented from passing through from one air stream to the other.
-  The regulations according to VDI 6022 are strictly fulfilled and certified.
-  Vapobloc does not freeze in normal winter conditions as most humidity is transferred to the supply air.
-  High cost saving on the humidifier. A smaller humidifier can be installed and the running costs are substantially lower.
-  Minimal Maintenance:  
Vapobloc is easy to clean and has no moving parts.





### Humidity transfer / Hygiene

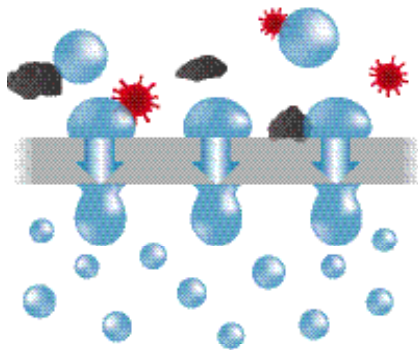

Vapobloc doesn't depend on pores or fragile surface-mounted desiccants to transfer humidity from one air stream to the other.

Instead, the dense functional copolymer layer separating the air streams absorbs water vapor creating liquid channels in the solid membrane. There is no physical opening, so the polymer is hermetic and prevents crossover of air or other gases. Only water molecules move through hydrophilic segments of the polymer membrane by a stepping-stone mechanism driven by the vapour pressure differential across the material.

Membran characteristics:

Air permeation <math><0.05 \text{ cm}^3/\text{cm}^2/\text{min}/\text{kPa}</math>

Water Vapor Flux: >28 kg/m<sup>2</sup>/d



### Freezing

Vapobloc does not freeze in normal winter conditions as most humidity is transferred to the supply air.

The annual payback of Vapobloc is therefore significantly higher compared to other recuperative systems like twin coils or plate heat exchangers due to more operating hours. Even if, under extreme circumstances, Vapobloc should still freeze, it will not be damaged. The risk of the Vapobloc freezing increases when operating at very cold outside air together with high humidity in the exhaust air and continuously use for more than one day.

### Definition of Frozen Plate Heat Exchanger

Freezing of a heat exchanger is not only a matter of temperature, but also of time. If action against freezing is taken too early, it means a big waste of energy. Normally the outside air temperature rises again during some hours or the exhaust air humidity gets lower, which creates less condensate.

If 1/3 of the heat exchanger is clogged, the heat exchanger is considered as frozen.

Assuming half the condensate is drained and the rest freezes, the below graph shows when frosting starts and at what outside air temperature the heat exchanger freezes after 24 or 48 hours depending on the exhaust air temperature.

All Polybloc Heat exchangers are resistant to Ice and Water.



**Example of freezing behaviour of VAPOBLOC CV**  
at 22°C extract air and different humidity levels

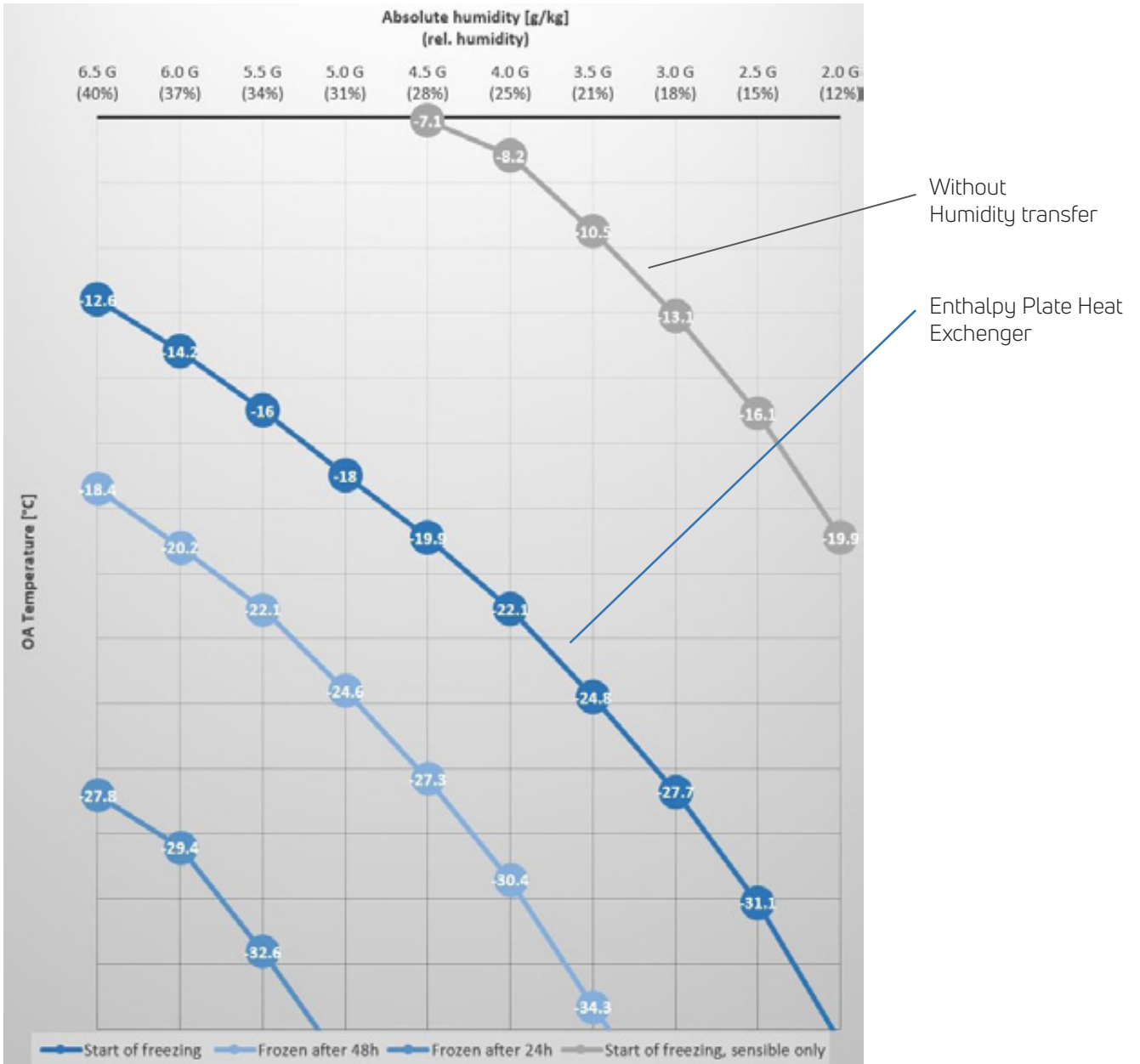

Start of Freezing: At this temperature the maximum relative humidity of the leaving air (100%) is reached. Below this temperature there will be some condensate

Frozen after 48 h:  
At this temperature and given humidity the unit will be frozen after 48 h \*

Frozen after 24 h:  
At this temperature and given humidity the unit will be frozen after 24 h \*

\*) Frozen means that half of the condensate freezes and is clogged by ice one third of the unit.





### The Selection Program WINPOLY

Using the selection program WINPOLY you can calculate the Vapobloc performance in the same way as our other products. The Blackbox DLL enables integration into your selection program.

The program is downloadable from [polybloc.com](http://polybloc.com)



### Cleaning

The Vapobloc should be checked regularly for dirt and be cleaned if necessary. At least once a year the Vapobloc must be cleaned in order to maintain its latent effectiveness.

Moderate contamination can be dealt with by rinsing the exchanger with warm tap water (max. 60°C). If necessary a mild dishwashing liquid such as Palmolive or Pril could be added.

Do not use a high pressure cleaner - it could damage the membranes.

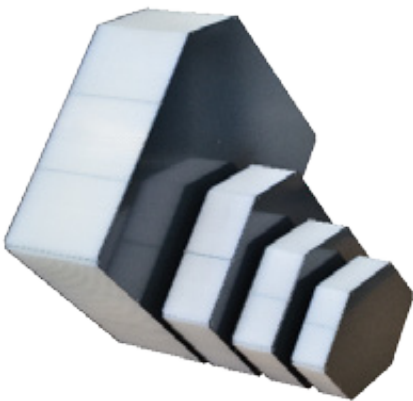

### Text for Specifications

- Enthalpy plate heat exchanger for the transfer of sensible and latent energy, through use of polymer membrane.
- Temperature efficiency dry not less than 73%  
Humidity efficiency not less than 60%
- Completely separated air streams by vapor permeable polymer with a vapor flux not less than 28 kg/m<sup>2</sup>/d
- Air tight with a maximal leakage rate of 0.5% at 250 Pa (1.0 inWC) pressure differential and 2 m/s face velocity. Proof by unique item test.
- Eurovent certified
- Incl. Hygiene certificate ISO 846 and VDI 6022
- Classification of reaction to fire performance. Class E, in accordance with EN 13501-1: 2018 and UL 900
- Tight against germs and smells
- Spacer for optimal air guidance
- Freeze- and water-resistant



## Sizes and Construction Counterflow VAPOBLOC - CV



### Enthalpy Counterflow - Plate Heat Exchanger CV

The Vapobloc-CV has the identical outside dimensions as the standard aluminium counter-flow plate heat exchanger.

Different sizes and adjustment of the width allow an optimal layout design relating to pressure loss and effectiveness.

If desired even with by-pass and damper.

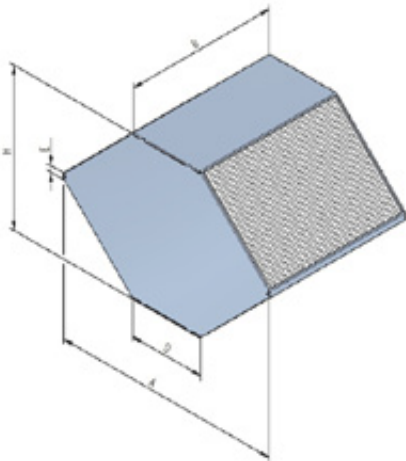
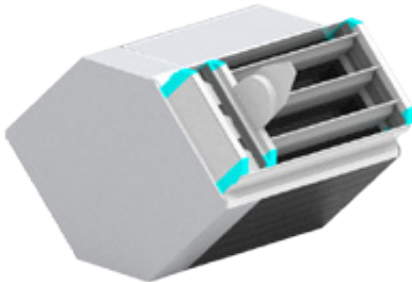

Type	A (mm)	D (mm)	E (mm)	H (mm)
CV-2-17-...-22	397	246	21	172
CV-4-23-...-23	454	246	21	230
CV-2-27-...-22	496	246	21	271
CV-2-31-...-22	535	246	21	310
CV-4-36S-...-23	366	194	14	366
CV-2-39-...-24	617	246	21	392
CV-2-53-...-24	757	246	21	532
CV-2-67-...-26	899	246	23	672
CV-2-81-...-26	1040	250	22	812
CV-2-95-...-26	1180	250	25	955
CV-2-120-...-24	1471	251	-	1220
CV-2-134-...-26	1612	251	-	1361
CV-2-148-...-26	1753	251	-	1501
CV-2-162-...-26	1894	251	-	1642
CV-2-176-...-26	2036	251	-	1784
CV-2-190-...-26	2178	-	1926	

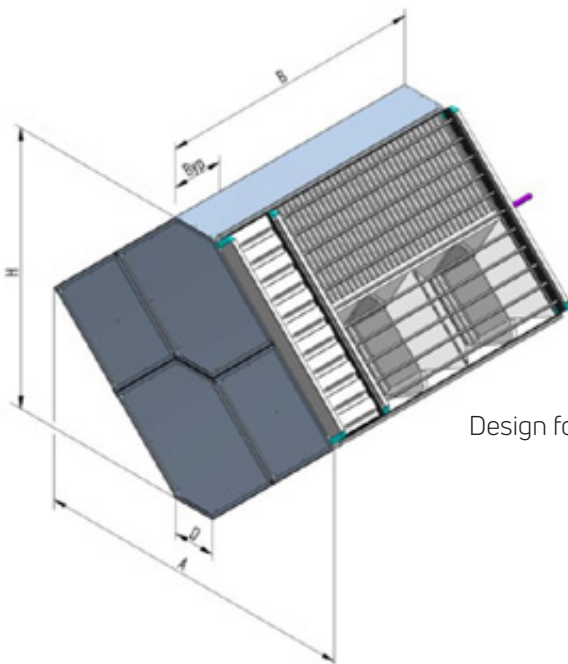

Design for sizes CV-2-120 to CV-2-190:



## Sizes and Construction Crossflow VAPOBLOC - VB



### Assembly / Sizes / Construction / Technical data

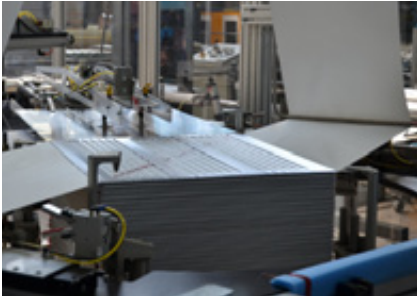

The Vapobloc is assembled in the same way as the classic POLYBLOC plate heat exchanger. The distance plates are made out of corrugated aluminium plates which gives the plate heat exchanger its unique mechanical stability.

Instead of a dividing plate between air streams Vapobloc uses a vapour permeable Copolymer stretched over the distance plates.

Different fin spacing and square lengths are available, allowing an optimal layout design relating to pressure loss and effectiveness.

Square length: 505, 605, 755, 1010, 1210, 1510, 2020, 2420 and 3020 mm

Fin spacing: 2.0, 2.5, 3.0, 3.5, 4.5 and 5.5 mm

Square length and fin spacing can be combined as required.

